

FOUNDRY P R O T E C T I O N



www.chicagoprotective.com



To our valued customers:

Chicago Protective Apparel Inc. has been committed to providing foundries with superior personal protective equipment since 1913. Naturally, during those one hundred-plus years, we have seen many changes in the industry. This unique foundry PPE catalog focuses on one of the most important aspects of those changes: the fabrics used to manufacture PPE apparel.

CPA has embraced many advances made in the textile industry, particularly where the development addresses concerns important to foundries. Current developments include improved fibers used to make yarns, new coatings and treatments applied to fabrics, and alternative approaches to the construction of weaves and knits. Each of these advances can translate to a higher level of protection, comfort, durability or economy. With so many changes happening, it can be difficult to identify the best solution for a particular need. Our hope is that this catalog will help you better understand some of the options.

CPA will always promote safety first, but we understand that safety engineers face the difficult task of balancing the requirements of safety with the limitations of budget, and the wearer's demand for comfort and durability. While we believe that many of the products in this catalog offer high value and increased comfort without compromising safety, all PPE performs differently in different environments. Therefore, on-site testing of our products against your particular hazard is as important as ever. CPA is happy to provide you with fabric swatches for testing, as we have seen materials perform very well in one environment, but fail in a seemingly similar environment. A slight variation in metals or environments can change the effectiveness of a PPE solution. As always, it is important to understand the difference between primary and secondary protective clothing, to wear FR undergarments under your secondary protective clothing, and to wear FR undergarments and secondary protective clothing under your primary protective clothing always. Heat stress and fatigue continue to be real challenges for foundry workers and safety engineers. Some of our ultra-lightweight and flexible fabrics may be great solutions for you; but again, in-house testing with samples is critical to ensuring that you have not sacrificed too much splash or radiant heat protection to achieve greater comfort.

Finally, in addition to new materials, CPA is focusing on improving our garment design. Many environments require custom designs to balance the competing demands of protection, comfort, economy, and durability. We can mix and match fabrics within the same garment. We can add protective patches, hi-vis tape, detachable sleeves or vented backs. There are as many solutions as there are safety challenges. Please call us to take advantage of our ability to customize your PPE solutions, or to further discuss any of the offerings you find in the following pages.

CPA is committed to staying on the cutting edge of safety advancements, just as we look forward to working with safety engineers to implement the best use of these advancements to meet each safety need.

Molten metal accidents are a serious threat to the safety of foundry workers. PPE made to protect against molten metal splash can save workers from disabling or potentially fatal burns and injuries. There are two key aspects of PPE geared towards foundry protection: flame resistance and the ability to shed molten metal.

1. Flame Resistance. Protective clothing must be made of fabric that is flame resistant so that it will not ignite and continue to burn after the heat source is removed. Additionally, FR fabrics should shield the wearer from second- and third-degree burns as much as possible.

2. Ability to Shed Molten Metal. The fabric must demonstrate the ability to shed molten metal from its surface without sticking.

There are standards in place to measure the performance of fabrics used to manufacture protective clothing. One is the ASTM F955 pour test, and another is the EN ISO 11612.

ASTM F955 Test

The ASTM F955 test is widely used in the industry to both demonstrate and measure the protective performance of fabrics against molten metal splash and heat transfer. Fabric is placed on a testing apparatus comprised of a heat sensor board placed at a 70 degree angle. One kilogram of molten iron or aluminum is poured directly onto the fabric, while the heat sensors in the board measure the temperature change on the backside of the fabric, and continuously monitor the transfer of heat across its surface.

Schematic of Test Apparatus Used for ASTM F955 Pour Test

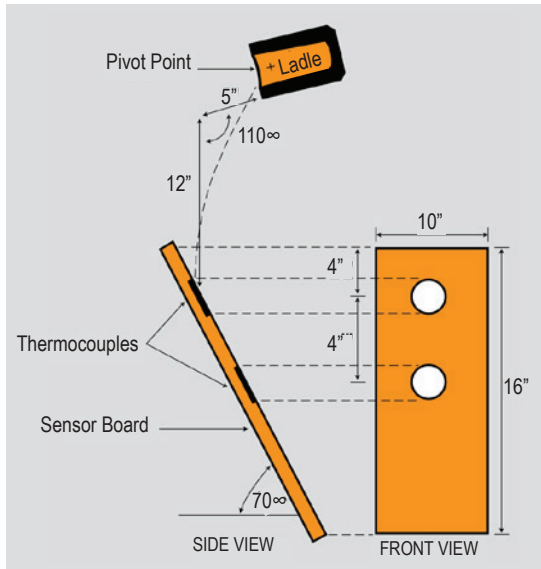

The measure of the protection level of a fabric is how much it can limit the amount of heat transferred to the wearer, and prevent a theoretical second degree burn. This test also demonstrates how quickly and effectively a fabric can shed molten metal without it sticking and burning through to the wearer.

One of the ways the results of an ASTM F955 pour test are reported is by a graph called a Stoll Curve. The Stoll Curve is a plot of the amount of time it takes for a second degree burn to occur. Anything falling beneath the Stoll Curve is considered safe from a theoretical second degree burn, and any results falling above the curve are not.

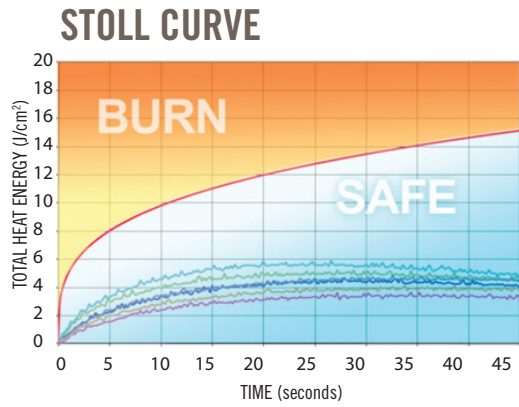

EN ISO 11612 Standard

The EN ISO 11612 is a European standard used to measure the protective performance of fabrics against flame, heat, and molten metal splash. It tests for several different properties including heat resistance, limited flame spread, convective heat, radiant heat, molten aluminum splash, molten iron splash, and contact heat.

Additionally, fabrics must retain a certain degree of structural integrity when exposed to hazards. The EN ISO 11612 also checks a fabric's physical properties such as dimensional change, tensile strength, tear strength, burst strength, and seam strength. We have added ratings for properties which pertain to foundry PPE, namely radiant heat, aluminum splash, and iron splash. The table below has the values for each classification level.

EN ISO 11612 / EN 531

CODE LETTER C Radiant Heat	CODE LETTER D Aluminum Splash	CODE LETTER E Iron Splash
C1 > 7 < 20s	D1 > 100 < 200g	E1 > 60g < 120g
C2 > 20 < 50s	D2 > 200 < 350g	E2 > 120g < 200g
C3 > 50 < 95s	D3 > 350g	E3 > 200g
C4 > 95s		

Evaluating Fabrics for PPE

The standards above are widely used and accepted as a way to measure the protective performance of fabrics. This brochure includes fabric profiles with descriptions, key benefits, test data, and the certifications attained, to provide PPE users with a start point for evaluating potential protective clothing solutions. Every work environment is unique with its own set of hazards, so we recommend that users conduct their own tests to determine the suitability and efficacy of products for their safety while on the job.

KEY TO INFORMATIONAL ICONS

- Flame Resistance
- Molten Iron Splash Resistance
- Abrasion Resistance
- High Heat Resistance
- Molten Aluminum Splash Resistance
- Lightweight
- Radiant Heat Resistance
- Cryolite Resistance
- Breathability

PRIMARY

PROTECTIVE CLOTHING



Foundry work such as charging, taping, and pouring molten metal can expose workers to dangerous thermal hazards and burn injuries. Primary protective clothing is the first line of defense against molten metal splash and other foundry hazards. It is part of the outer layer of a personal protective equipment (PPE) system. Garments such as heavy jackets and coats, hoods, full-body approach suits, pants, coveralls, leggings, overshoes, and spats can be combined to obtain the level of protection needed for the task at hand. There are various fabrics available for manufacturing effective primary protective clothing. Many are aluminized, however there are some newer non-aluminized options as well.

ALUMINIZED

Aluminized fabrics are built with a base layer of a protective, flame-resistant fabric, and finished with an aluminized coating. The mirrored surface of aluminized fabrics makes it extremely effective at reflecting radiant heat. It can reflect up to ninety-five percent (95%) of thermal radiation, and some fabrics withstand intermittent exposure to temperatures as high as 3000°F. Depending on the properties of the base fabric and the particular aluminization process it has undergone, aluminized fabrics also have varying degrees of resistance to cut and abrasion, flame, high heat, chemical and molten metal splash.

NON-ALUMINIZED

Although aluminized clothing is very effective protection from foundry hazards, it can also be heavy, rigid, and bulky. The additional weight can cause workers to expend more energy, leading to fatigue and heat-stress related injury. In recent years there has been a demand for alternatives to aluminized fabrics for primary protective apparel. Although these fabrics are lighter, more breathable, flexible, and comfortable than aluminized fabrics, they provide outstanding protection from molten metal splash. They are an excellent choice when there is little or no danger from radiant heat. Otherwise, workers need protective clothing made of fabric with a reflective surface.

Besides the properties of the fabrics, garment design is very important for making effective protective clothing. We have many design options which can be customized according to your protective needs. Our design department uses the latest tools, industry best practices, and standards (e.g., the ASTM International), to ensure that our garments will have a great fit and function properly on the body.

STANDARD

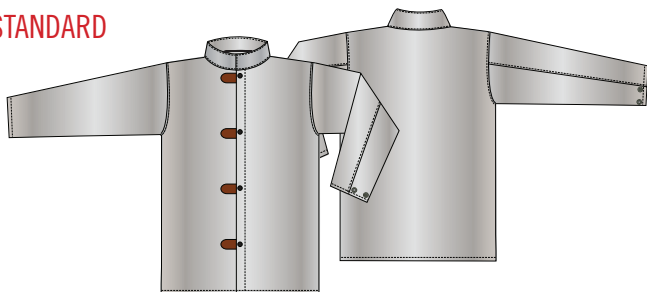

Our "Standard" design provides a generous fit that suits most body types. This design limits the number of seams in the garment and gives the wearer 360 degrees of coverage. Our "Standard" design is economical and popular.

VENTED BACK

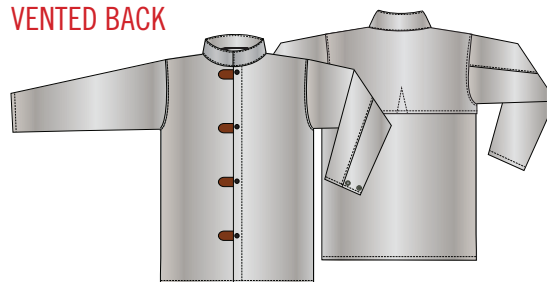

Adding a vent to the back of a jacket promotes circulation of ambient air. The overlapping fabric reduces the chance of sparks or splash getting through the vent, and is an excellent solution if the front of the body typically faces the hazard.

COMBO

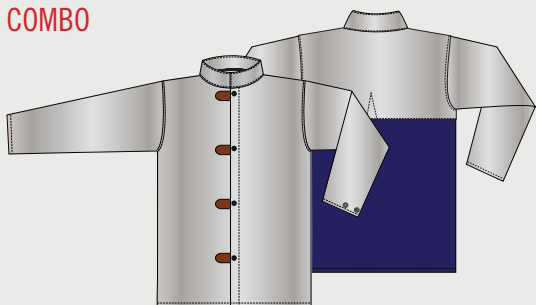

The combination jacket allows users to have different fabrics in the front and back of the same garment. Typically used to reduce weight or cost, it can substantially increase comfort. This design comes standard with a vented back adding breathability. The "Combo" jacket is often worn when the more severe hazards face the front of the body.

DETACHABLE SLEEVES

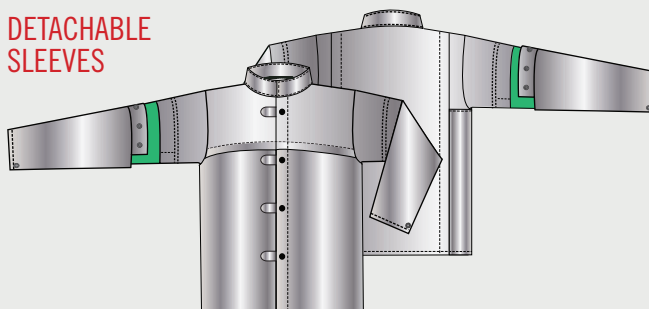

Snap-on / snap-off sleeves provide users with a solution to premature wearing of sleeves in harsh environments. Replacement sleeves can be purchased separately to help extend the life of the jacket. Feel free to mix or match sleeve fabrics for unique requirements.



ERGOSTYLED

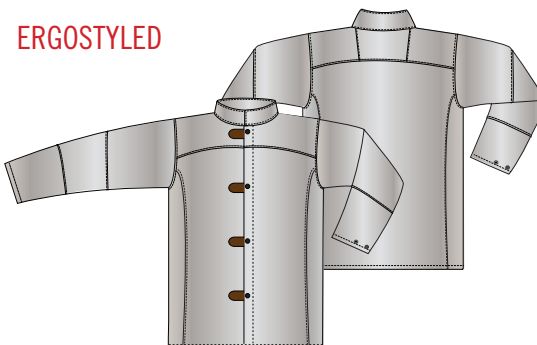

A more fitted jacket style, with pre-curved sleeves and arced shoulder yoke. The "Ergo" design allows for better mobility and enhanced comfort. It is well-suited for lightweight and flexible aluminized fabrics.



JACKET LENGTHS



6'

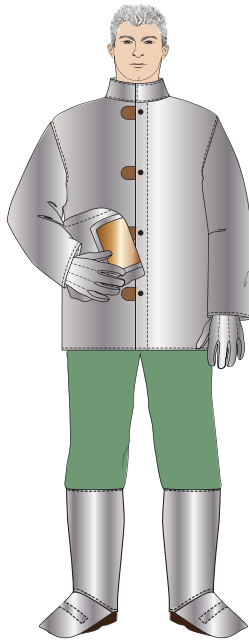

30"
600 Style

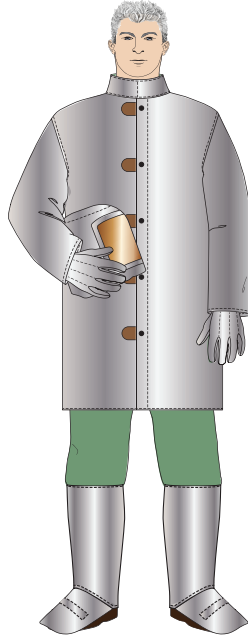

40"
601 Style

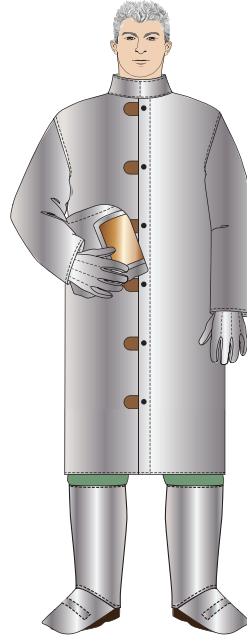

45"
602 Style

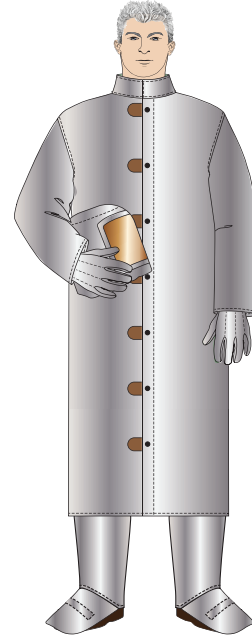

50"
603 Style

HEAD & FACE PROTECTION

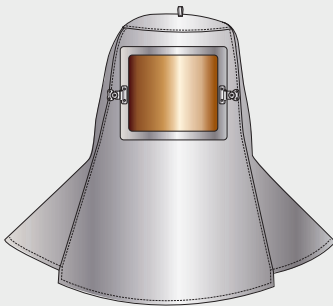

0647
Hood

- Lexan® window
- Replaceable gold film
- Heavy duty butterfly latch
- Aluminum window bracket

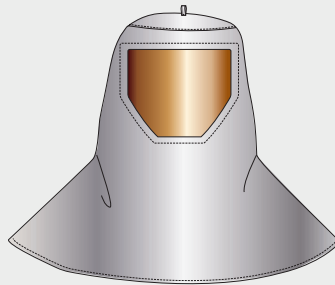

WV-647
Hood

- 10" x 20" x .060" window
- Made from 8 oz. polycarbonate
- Injection molded shield
- Clear / gold color
- Cap bracket to attach to hard hat

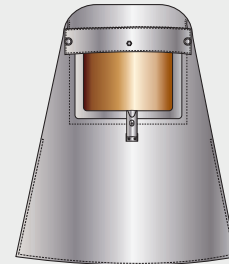

220
Hood

- 7" x 11" lift front window
- Shoulder slits



690
Spark Deflector

Deluxe Velcro™ design spark deflector. Four Velcro™ straps attach FR green band to inside of hard cap suspension. The removable deflector attaches to the green band with Velcro™. Available in various fabrics.

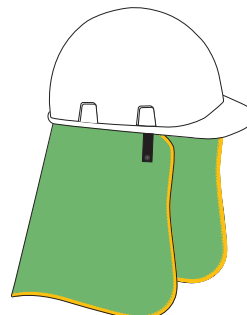

ESD-690
Spark Deflector

Economy spark deflector made for use with hard hat. Four webbing straps loop over hard cap suspension and snap in place. Available in various fabrics.

606 Pants



- Snap front closure
- Belt loops
- No pockets
- 32" standard inseam

Bib Apron

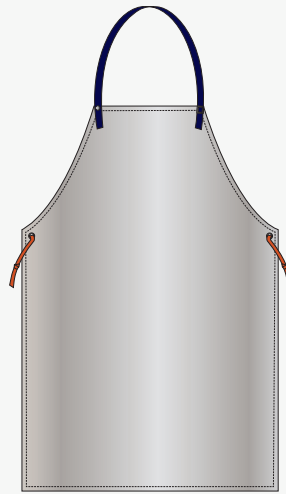

Our bib aprons are available in many different fabrics and closures to meet your protection needs. They come in 30", 36", 39", 42", and 48" lengths.

Sleeve

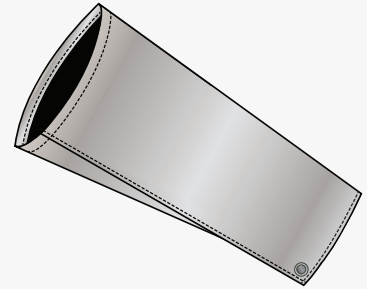

Safety sleeves come in all fabrics and choice of closure. Standard sleeve closure is snap at wrist and open top. They are available in the following lengths: 9", 12", 14", 18", and 23".

555 Chaps

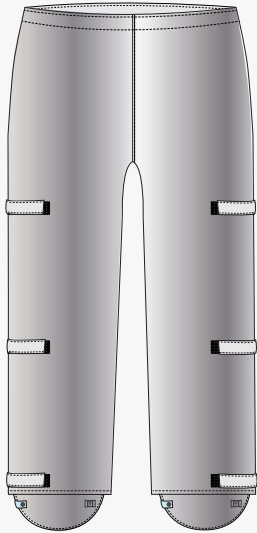

Adjustable belt top. Rear leg straps. 39" outseam. Open back.

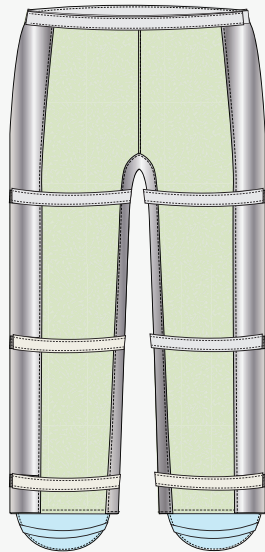

HL-777 Attached Hip Legging

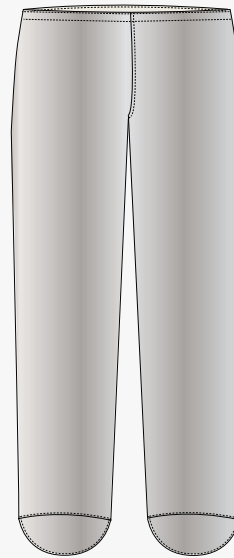

Attached hip legging with adjustable belt top. 38" outseam. Please specify if snap or Velcro™ closure is needed at back of leg.

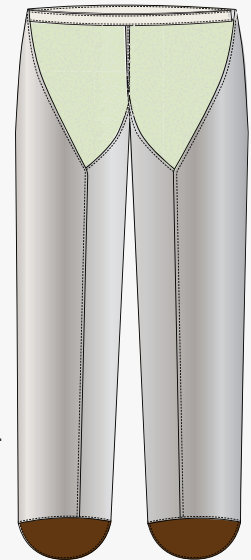

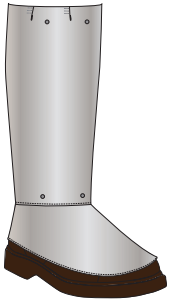

300 Standard Spring Leggings

Spring frame permits instant adjustment and easy removal. Wide rear flap provides full protection to the back of the leg. 14" legging with 6" flare.

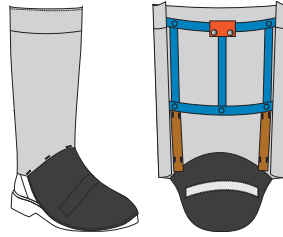

333 Replaceable Cover Leggings

Deluxe style with removable cover for economical replacement cost. Snap out steel frame assures full-time comfortable fit. Metal instep bar forms and holds flare to shoe. 14" height with 7" flare.



401 Full Vertical Velcro™ Closure Leggings

Full Velcro™ closure. Fast removal, lightweight solution. Metal instep bar standard. 14" legging with 8½" flare. Available in sizes, Large, X-Large, and Jumbo (2X) to accommodate workers with larger calves.

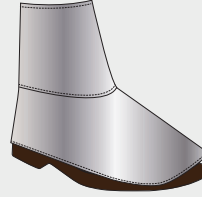

485 Spat

Standard safety spat. Rear Velcro™ closure. Easily adjusted or removed. 7" height, 6" flare.

671 Overshoe

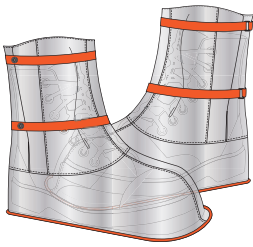

12" overshoe with 1/4" neoprene skid-resistant belting sole. Designed to be worn over work shoes. The double strap slide buckle closure holds the overshoes in place. Also available in 8" and 16" heights.

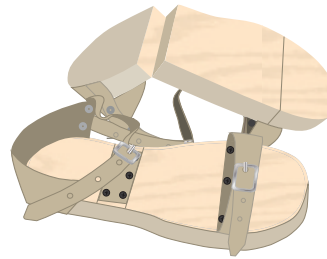

351-CPA "Hot Foot" Wood Shoes

No need to go to Holland for wood shoes! With a wood sole that bends, these shoes are made of 1-inch thick seasoned wood. They have two strong sole leather hinges, strap on quickly over any shoe, and are heat-resistant and puncture-resistant.





ALUMINIZED PARA-ARAMID BLEND



FABRIC PROFILES



Safety sleeves and bib apron in aluminized para-aramid blend

FABRIC DATA & CERTIFICATIONS

ASTM F955

IRON SPLASH

NO BURN

ALUMINUM SPLASH

NO BURN

EN ISO 11612

C1

C2

C3

C4

RADIANT HEAT

D1

D2

D3

ALUMINUM SPLASH

E1

E2

E3

IRON SPLASH

Aluminized para-aramid blend is a strong and extremely heat resistant fabric. It is composed of para-aramid blend fibers surrounding fiberglass materials, and finished with an aluminized coating.

Like many of the other aluminized primary protective fabrics, it performs very well on tests for both the EN 531 (presently superseded by the EN ISO 16112), and ASTM F955 certifications. Aluminized para-aramid blend provides a high degree of protection from molten aluminum and iron splash, as well as radiant heat. However, its fiberglass content also makes it protective against high contact heat, withstanding temperatures of 400-600° F.

The fabric weight, its molten metal splash protection, and its high contact heat capability make it a great choice for gloves, mitts, safety sleeves and aprons. It also lends itself well to any garments worn where there is a higher probability of contact, or handling of extremely hot surfaces or objects.

KEY FEATURES

- Can withstand contact temperatures of 400-600° F
- Durable
- High cut and abrasion resistance

FABRIC COMPOSITION & CHARACTERISTICS

- Combination of para-aramid fibers surrounding fiberglass materials with aluminum coating
- Fabric Weight: 19 oz. / sq. yd.
- CPA Fabric Designation: AKV



ALUMINIZED CARBON PARA-ARAMID BLEND



Aluminized carbon para-aramid blend combines the strength, flexibility, heat resistance, and cut and abrasion resistance of carbon para-aramid blend, with the radiant heat protection of aluminized protective fabrics. The base fabric is a blend of para-aramid fiber and a carbon yarn. On its own, para-aramid blend is best known for its strength, excellent resistance to cuts and abrasions, and high contact heat. The carbon core further adds to the fabric's durability and chemical resistance, while also providing more flexibility and softness.

Aluminized carbon para-aramid blend displays outstanding performance in tests for the EN ISO 11612 and ASTM F955 certifications. It resists both molten aluminum and iron splash, and achieves the highest classification for radiant heat protection.

As aluminized primary protection, this fabric is an outstanding choice. Aluminized carbon para-aramid blend is well-suited for being made into jackets, coats, mitts, and other outer layer garments.

KEY FEATURES

- Resists both molten iron and aluminum splash
- Excellent cut, abrasion, and heat resistance
- Durable
- High heat tolerance
- Flexible

FABRIC COMPOSITION & CHARACTERISTICS

- Para-aramid blend fiber with a carbon yarn, finished with an aluminized coating
- Fabric Weight: 19 oz. / sq. yd.
- CPA Fabric Designation: ACK



Style 300 standard spring leggings in aluminized carbon para-aramid blend

FABRIC DATA & CERTIFICATIONS

ASTM F955

IRON SPLASH

NO BURN

ALUMINUM SPLASH

NO BURN

EN ISO 11612

C1	C2	C3	C4	RADIANT HEAT
D1	D2	D3		ALUMINUM SPLASH
E1	E2	E3		IRON SPLASH



TRU ALUMINIZED CARBON PARA-ARAMID BLEND



Back view of HL-777 style attached hip leggings in TRU aluminized carbon para-aramid blend

TRU aluminized carbon para-aramid blend, or TRU ACK, consists of a base substrate of aramid fiber blend over an oxidized PAN (OPF) core yarn, with an aluminized coating on one side. The combination of carbon fibers with para-aramid give the fabric a light green appearance, plus more flexibility and durability.

This fabric is highly recommended for molten metal splash protection. It has achieved the highest marks for molten aluminum and iron splash (D3 and E3, respectively), according to the European standard EN ISO 11612. It also passes the American ASTM F955 tests for molten metal splash resistance. TRU ACK displays outstanding radiant heat protection, and excellent thermal protection.

TRU ACK is an excellent fabric for protective clothing and industrial applications. It works well for outer layer garments such as jackets, coats, mitts, gloves, and hoods.

KEY FEATURES

- Achieves highest ratings for both molten iron and aluminum splash resistance
- Outstanding radiant heat protection
- Combines strength and abrasion resistance with more flexibility, due to the blend of aramid fiber and carbon yarn

FABRIC COMPOSITION & CHARACTERISTICS

- Aramid fiber blend over an oxidized PAN (OPF) core yarn, aluminized on one side
- Fabric Weights: 14 oz. / sq. yd. and 19 oz. / sq. yd.
- CPA Fabric Designations: ACK13 - 14 oz. / sq. yd. and ACK16 - 19 oz. / sq. yd.

FABRIC DATA & CERTIFICATIONS

ASTM F955 • 14 oz. & 19 oz.

IRON SPLASH	ALUMINUM SPLASH
NO BURN	NO BURN

EN ISO 11612 • 14 oz. & 19 oz.

C1	C2	C3	C4	RADIANT HEAT
D1	D2	D3		ALUMINUM SPLASH
E1	E2	E3		IRON SPLASH

1 ALUMINIZED CARBON FLEECE



Aluminized carbon fleece is another fabric developed in response to a demand for lightweight, more flexible, and comfortable primary protective clothing. At 12 oz. / sq. yd., this fabric is still able to pass the ASTM F955 pour test for both molten iron and aluminum, while providing comfort, reduced heat stress, and increased productivity. Even after aluminization, the fleece base fabric remains soft and flexible.

Carbonized fibers blended with rayon knit fleece make up the base of aluminized carbon fleece. It is inherently flame resistant, protects against molten metal splash, provides maximum temperature resistance, and will not burn, melt or ignite.

KEY FEATURES

- Lightweight, soft, and flexible
- Protects against both molten iron and aluminum splash
- High temperature resistance
- Will not melt or ignite

FABRIC COMPOSITION & CHARACTERISTICS

- Carbonized fibers combined with rayon knit fleece with aluminum coating
- Fabric Weight: 12 oz. / sq. yd.
- CPA Fabric Designation: ACF

555 style chaps in aluminized carbon fleece



FABRIC DATA & CERTIFICATIONS

ASTM F955

IRON SPLASH

NO BURN

ALUMINUM SPLASH

NO BURN



234 style high heat gloves in heavy aluminized rayon and WV-647 style hood in aluminized rayon

Aluminized rayon, available in both 15- and 19 oz. / sq. yd. weights, is well known as a comfortable, yet effective, fabric for aluminized protective clothing. It is very flexible and lightweight, which reduces heat stress and fatigue, and enhances the wearer's comfort. Aluminized rayon displays excellent radiant heat, molten aluminum, and iron splash protection according to the EN 531 standard (which has been superseded by the ISO EN 16112), and the ASTM F955 test. This fabric is one of the more economical options available for manufacturing aluminized protective clothing.

KEY FEATURES

- Light and flexible
- Economical
- Great choice if user needs radiant heat and molten metal protection, but does not require high contact heat resistance

FABRIC COMPOSITION & CHARACTERISTICS

- Rayon with aluminum coating
- Fabric Weights: 15- and 19 oz. / sq. yd.
- CPA Fabric Designations: AR: 15 oz. / sq. yd. and ARH: 19 oz. / sq. yd.

FABRIC DATA & CERTIFICATIONS

ASTM F955 • 15 oz. & 19 oz.	
IRON SPLASH	ALUMINUM SPLASH
NO BURN	NO BURN

EN ISO 11612 • 15 oz. & 19 oz.			
C1	C2	C3	C4 RADIANT HEAT
D1	D2	D3	ALUMINUM SPLASH
E1	E2	E3	IRON SPLASH



Aluminized Trutex™ is a non-woven fabric with a para-aramid batting, OPF batting, and meta-aramid scrim, which is coated with aluminum on one side. It is constructed using the time-tested technique of adhering pure aluminum to both sides of a thin polyester film, and adding it to a flame resistant textile substrate.

The base fabric is essentially a carbon para-aramid blend, which makes it very strong and tear-resistant. It has the characteristic pea green and black speckled appearance, yet has a soft, fleece-like texture.

Aluminized Trutex™ is a great choice for molten metal splash and radiant heat protection. It is relatively light and flexible, and garments made from it will be more comfortable to wear. This very protective fabric is well-suited for jackets, coats, mitts, gloves, and other protective garments.

KEY FEATURES

- Lightweight, soft, and flexible
- Protects against both molten iron and aluminum splash
- Very good thermal protection
- Excellent radiant reflectivity

FABRIC COMPOSITION & CHARACTERISTICS

- Non-woven, para-aramid and OPF batting, meta-aramid scrim with aluminized layer
- Fabric Weight: 10 oz. / sq. yd.
- CPA Fabric Designation: ATX

602 style jacket from aluminized Trutex™



FABRIC DATA & CERTIFICATIONS

ASTM F955	
IRON SPLASH	ALUMINUM SPLASH
NO BURN	NO BURN

EN ISO 11612			
C1	C2	C3	C4 RADIANT HEAT
D1	D2	D3	ALUMINUM SPLASH
E1	E2	E3	IRON SPLASH



690 spark deflector in aluminized CarbonX®

Aluminized CarbonX® by Textech Industries is a lightweight, and more comfortable choice in aluminized primary protective apparel. It works well for outer layer garments such as coats, jackets, hoods, full-body suits, pants, leggings, overshoes, and spats. The combination of non-flammable CarbonX® and Z-Flex® aluminization provides outstanding protection from molten metal splash and high temperatures.

CarbonX® is a high-performance, truly non-flammable fabric that will not burn, ignite, or melt, and protects against molten metal splash, sparks, hot liquids, and high temperatures. Through the Z-Flex® MLA™ process, or multilayer aluminization, the CarbonX® base becomes coated with several layers of aluminum, protective films, and high heat adhesives. If one layer breaks down, there is another available to protect.

At 12 oz. / sq. yd., aluminized CarbonX® is among the lightest fabrics that can pass the ASTM F955 pour test for both aluminum and iron. It also receives high marks for radiant heat protection, and aluminum and iron molten metal splash resistance, according to the European standard EN ISO 11612.

KEY FEATURES

- Lightweight and comfortable
- Resists both molten aluminum and iron splash

FABRIC COMPOSITION & CHARACTERISTICS

- CarbonX®, a proprietary blend of high-performance fibers, with Z-Flex® Multi-Layer Aluminization
- Fabric Weight: 12 oz. / sq. yd.
- CPA Fabric Designation: ACX10

FABRIC DATA & CERTIFICATIONS

ASTM F955

IRON SPLASH

NO BURN

EN ISO 11612

C1	C2	C3	C4	RADIANT HEAT
D1	D2	D3		ALUMINUM SPLASH
E1	E2	E3		IRON SPLASH



A3D is an aluminized fabric developed by Newtex Industries, with the intent of providing a breathable proximity shell. Surface micro-perforations allow for the escape of body heat and moisture. A3D is a lighter, more breathable fabric, made to help keep the wearer cool and comfortable, without sacrificing the protection of traditional aluminized fabrics. Additionally, the OPAN / para-aramid blend base fabric is a mock knit weave with more than two times the tensile and tear strength of knits, yet maintains all the comfort and flexibility of traditional knit fabrics

KEY FEATURES

- 300% more breathability than traditional aluminized outer shell materials
- More abrasion resistant than traditional aluminized fabrics
- Helps keep the wearer cool, allowing for greater safety and productivity

FABRIC COMPOSITION & CHARACTERISTICS

- Mock-knit weave OPAN / para-aramid blend and coated with Z-Flex® Multi-Layer Aluminization with Micro-Perforation
- Fabric Weight: 14.5 oz. / sq yd.
- CPA Fabric Designation: A3D
- CPA Exclusive



600 style jacket in A3D

FABRIC DATA & CERTIFICATIONS

ASTM F955

IRON SPLASH

NO BURN



**ALUMINIZED
PBI®**



FABRIC PROFILES



647 hood variation in aluminized PBI®

Aluminized PBI® is a knit blend of PBI® and para-aramid blend fibers, with an aluminized coating. Despite being extremely lightweight and supple, aluminized PBI® provides superior resistance to abrasions and chemical solvents, yet provides wearers with greater comfort and reduced fatigue.

On its own, PBI® is an organic fiber with very unique properties. It was originally developed for NASA's Project Apollo, in response to the need for greater heat protection. It does not burn in air, melt, or emit toxic fumes. The addition of para-aramid blend provides extra strength and abrasion resistance.

KEY FEATURES

- Light, comfortable, and flexible
- Can withstand very high contact temperatures
- Excellent thermal, abrasion, and chemical resistance

FABRIC COMPOSITION & CHARACTERISTICS

- PBI® / para-aramid blend fibers with aluminum coating
- Fabric Weight: 7 oz. / sq. yd.
- CPA Fabric Designation: APBI
- Recommended for radiant heat and flame protection
- Not recommended for heavy molten metal splash

FABRIC DATA & CERTIFICATIONS

NFPA 1971-2013

1 ALUMINIZED BASFLEX RIPSTOP



Aluminized Basflex ripstop is a lightweight, versatile, and flexible aluminized fabric with outstanding protection against flame, molten metal splash, and radiant heat. It is a blend consisting of 17% melamine, 83% para-aramid, and is aluminized on one side.

Melamine has excellent dimensional stability, superior thermal protective performance (TPP) value, low thermal conductivity, ultraviolet (UV) radiation resistance, and combines well with other fibers when processed into fabrics. Another characteristic is that it is non-toxic with no VOC (volatile organic compounds) off-gassing, which makes it safe for PPE garments. The addition of para-aramid to the blend reinforces the fabric's thermal protective properties, and adds strength and durability. Finally, the aluminized coating provides superior protection from radiant heat.

Aluminized Basflex riptstop meets several safety standards, including the ASTM F955, EN ISO 16112, and the NFPA 1971-2018. These standards cover both molten metal splash for fabrics used in industrial settings, and fire fighters' apparel and turnout gear.



601 style jacket in aluminized Basflex ripstop with front Velcro® closure

KEY FEATURES

- Excellent radiant heat protection
- Lightweight and flexible
- Molten metal splash protection for both aluminum and iron
- Meets ASTM F955, EN ISO 11612, NFPA 1971-2018

FABRIC COMPOSITION & CHARACTERISTICS

- 17% melamine, 83% para-aramid, coated with aluminum laminate on one side
- Fabric Weight: 7.5 oz. / sq. yd.
- CPA Fabric Designation: ABF

FABRIC DATA & CERTIFICATIONS

ASTM F955

IRON SPLASH

NO BURN

ALUMINUM SPLASH

NO BURN

EN ISO 11612

C1

C2

C3

C4

RADIANT HEAT

D1

D2

D3

ALUMINUM SPLASH

E1

E2

E3

IRON SPLASH

NFPA 1971-2018

SECONDARY

PROTECTIVE CLOTHING

Secondary protective clothing, designed for continuous wear, shields workers against intermittent exposure to foundry hazards. In settings where there is persistent and significant exposure to such hazards, secondary protective clothing provides an additional layer of flame resistant protection when worn with primary protective clothing. If exposed to flame, the clothing will stop burning with the removal of the ignition source. As the name implies, protection from molten metal splash and radiant heat are secondary in intent.

There are a variety of protective fabrics to choose from depending on the type of metal and other hazards unique to the particular work setting. Secondary protective fabrics generally fall into one of the following categories: fabrics that shed ferrous metals, those that shed aluminum, and those that shed both ferrous metals and aluminum.

Ferrous Metals Only	Aluminum Only	Ferrous Metals • Aluminum • Copper • Brass Nickel • Lead • Various
CarbonX®	Vinex®	Marlan® Plus
Indura®		Oasis®
Quantum Valen-T		Carbon Para-Aramid Blend
Repel™		
Marko Cotton		

In addition to their protective qualities, fabrics used in the design and manufacture of secondary protective clothing are generally lightweight, breathable, flexible, and comfortable. They lend themselves well to garments worn close to the skin, such as underwear, socks, long sleeve t-shirts, button-down work shirts, pants, light jackets, bib overalls, and coveralls.





Textech Industries' CarbonX® is a blend of high-performance fibers that will not burn, melt, or ignite, even when subjected to direct flame.

One of the most notable characteristics of CarbonX® is its high Limiting Oxygen Index, or LOI. A fabric's LOI measures the amount of oxygen needed in the environment for combustion to occur. The oxygen volume of air, 20.95, is used as a benchmark when discussing the LOI of a fabric. Any fabric with an LOI under 20.95 will burn in air. CarbonX® boasts an LOI of 55, indicating that it needs almost three times the amount of oxygen in air to combust. What makes this possible is the behavior of the patented fiber blend in the presence of heat and flame. CarbonX® fibers carbonize and expand when exposed to heat and flame, thereby eliminating the oxygen in the fabric.

CarbonX® comes in various weights of woven and knit fabrics. Knit CarbonX® is excellent when used in baselayer garments and next-to-skin applications. It is very lightweight, flexible, and soft-to-the-touch, while protecting the skin from burn injuries. Woven CarbonX® fabrics are a great choice for secondary protection garments, such as work shirts, bib overalls, pants, and coveralls.

KEY FEATURES

- Breathable, comfortable, and lightweight
- Withstands repeated industrial launderings without losing its FR protective properties
- Sheds ferrous metals

FABRIC COMPOSITION & CHARACTERISTICS

- Fabric Weights: 10 oz. / sq. yd. and 11 oz. / sq. yd.
- CPA Fabric Designations: CX10 - 10 oz. and CX11 - 11 oz.



600 style jacket with striping and 618 style bib overall in CarbonX®

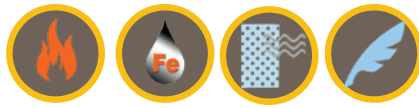

600 style jackets
in orange and green
Indura®

The Indura® brand name was derived from "industrial (wash) durability," and was engineered to retain its FR properties for the life of the garment. Since Westex introduced it in 1987, millions of garments made from Indura® have been part of protective clothing programs worldwide. Indura® continues to be popular among workers in the metal industry, and contractors seeking out FR protective clothing.

Indura® is light, comfortable and breathable, yet protective. According to the European standard, the EN ISO 11612, Indura® provides excellent molten iron splash resistance. It also provides protection from other hazards such as electric arc, flash fire, and welding exposures.

Since Indura® is 100% cotton, it lends itself well to secondary protective garments such as coveralls, pants, button-down shirts, t-shirts, sweatshirts, hoodies, denim jeans, and light jackets. It is available in a large variety of colors.

KEY FEATURES

- Guaranteed flame resistant for the life of the garment
- Multipurpose protection from electric arc flash, flash fire, molten ferrous metal, and welding exposures.
- Double-shrunk technology
- Lower initial cost
- Comfort of cotton
- Available in various colors

FABRIC COMPOSITION & CHARACTERISTICS

- 100% cotton
- Fabric Weights: 9 oz. / sq. yd. and 12 oz. / sq. yd.
- CPA Fabric Designations: IND - 9 oz. and IND315 - 12 oz.

FABRIC DATA & CERTIFICATIONS

EN ISO11612

IRON SPLASH

9 OZ. / SQ. YD. INDURA®

E1 E2 E3

12 OZ. / SQ. YD. INDURA®

E1 E2 E3



CarbonX® CR-80 Repel, or simply Repel™, is a lightweight and comfortable fabric designed to protect against foundry hazards. A blend of high performance fibers and a proprietary compound makes it possible for sparks and molten metal splash to roll off the surface of the fabric. It is also protective against hazards from petrochemical applications, hot chemicals, flammable liquids, and high heat processes used in pulp and paper manufacturing. Like CarbonX®, it will not burn, ignite, or melt, even when exposed to direct flame. Additionally, the coating is formed from an encapsulated barrier of silicone which shields against the elements and enhances the fabric's protective properties.

Despite its light weight at 9.5 oz. / sq. yd., Repel™ is able to pass the ASTM F955 test and limits heat transfer very effectively. This reduces the amount of muscle exertion and heat stress that builds up over the course of a work shift. Even though it is water-resistant, it is still breathable thanks to the micro-pores in the fabric.

After intense exposure and repeated industrial launderings, Repel™ continues to protect and maintains its strength and integrity.

KEY FEATURES

- Breathable, comfortable, and lightweight
- Withstands repeated industrial launderings without losing its FR protective properties
- Sheds ferrous metals

FABRIC COMPOSITION & CHARACTERISTICS

- Blend of high-performance fibers combined with a proprietary compound, surrounded by an encapsulated layer of silicone
- Fabric Weight: 8.5 oz. / sq. yd.
- CPA Fabric Designation: CX8C



602 style jacket in Repel™ with loops to hold radio.

PLEASE NOTE: Loops to hold radio are custom features and do not come standard on 602 garments

FABRIC DATA & CERTIFICATIONS

ASTM F955

IRON SPLASH

NO BURN



603 style coat with front snap closure over 606 pant in Oasis®

TenCate Oasis® is an innovative protective fabric that offers incredible softness, flexibility, and a lightweight feel. It is a blend made up of 50% Lenzing™ FR, 40% wool, and 10% nylon. Oasis® is designed to protect from multiple foundry hazards. For molten metal splash, it is classified as D2 for aluminum, and E3 for iron, according to Europe's EN ISO 11612 certification. Additionally, Oasis® protects from heat and flame.

Oasis® is inherently flame resistant, so its protective properties will not wash out or diminish with repeated laundering or wear. It is engineered for rugged performance so it retains its color, structural integrity, and super-soft, lightweight feel and flexibility.

KEY FEATURES

- Sheds both molten aluminum and iron splash
- Good resistance to cryolite
- Protects from multiple foundry hazards
- Inherently FR
- Retains color, soft feel, and flexibility
- Withstands repeated home or industrial launderings

FABRIC COMPOSITION & CHARACTERISTICS

- 50% Lenzing™ FR, 40% wool, 10% nylon
- Fabric Weights: 10 oz. / sq. yd. and 12 oz. / sq. yd.
- CPA Fabric Designations: ON10 - 10 oz and ON12 - 12 oz.

FABRIC DATA & CERTIFICATIONS

EN ISO 11612

ALUMINUM SPLASH			IRON SPLASH		
10 OZ. / SQ. YD.			10 OZ. / SQ. YD.		
D1	D2	D3	E1	E2	E3
12 OZ. / SQ. YD.			12 OZ. / SQ. YD.		
D1	D2	D3	E1	E2	E3



Vinex®, a blend of 85% vinyl and 15% polynosic rayon, was introduced by Westex as a response to the need for a lightweight fabric resistant to molten aluminum splash. It has been extensively tested at the BTTG Laboratories in the United Kingdom, and certified to EN ISO 11612 standards. Both the 8.5 oz. and 11.5 oz. weights of Vinex® have been classified as C1 for radiant heat, and D1 and D2 for molten aluminum splash, respectively.

Vinex® is inherently flame resistant and will retain its FR properties throughout the service life of the garment. Heavier styles of Vinex® will offer greater protection from second-degree burns than lighter styles, since insulation from thermal heat sources is directly related to fabric weight. Vinex® is very lightweight, breathable, comfortable, and works well for garments worn close to the skin underneath primary protective garments.

KEY FEATURES

- Specially designed to shed aluminum
- Retains flame resistant properties throughout the service life of the garment
- Lightweight, breathable, and comfortable
- Lauanders easily with conventional industrial laundry equipment and processes

FABRIC COMPOSITION & CHARACTERISTICS

- 85% vinyl and 15% polynosic rayon blend
- Fabric Weights: 8.5 oz. / sq. yd. and 11.5 oz. / sq. yd. Also available in 6 oz. / sq. yd. weight
- CPA Fabric Designations: FR9B-8.5 oz. and FR9B11-11.5 oz.



625 style two pocket front button down shirt in Vinex®

FABRIC DATA & CERTIFICATIONS

EN ISO 11612

ALUMINUM SPLASH

8.5 OZ. / SQ. YD. VINEX®

11.5 OZ. / SQ. YD. VINEX®

D1

D2

D3

D1

D2

D3

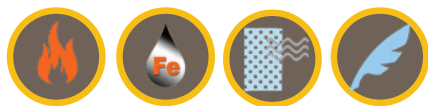

QUANTUM VALEN-T

FABRIC PROFILES



601 style jacket in Quantum Valen-T with striping, para-aramid blend knit cuffs with thumb hole

FABRIC DATA & CERTIFICATIONS

EN ISO 11612

E1 E2 E3

IRON SPLASH

ASTM F955

IRON SPLASH

NO BURN

Quantum Valen-T is a flame resistant fabric that is used in foundry settings. Quantum is a treatment with a proprietary flame retardant additive at the base fabric fiber, which results in outstanding protection from molten metal splash, welding sparks, slag, and other thermal hazards. Since the additive bonds directly to the fabric fibers and becomes part of their structure, the protective properties will not wash out even with repeated industrial launderings.

Quantum's base fabric, Valen-T, is inherently flame resistant and a good choice for applications where flame resistance is a key requirement. The Quantum process only enhances the FR protective properties of the base fabric, along with the fabric's ability to shed molten metal.

Quantum Valen-T is very light, comfortable, and breathable, making it a great choice for secondary protective apparel. It can also be worn in cases where there is flame and molten metal hazard present, without extreme radiant heat.

KEY FEATURES

- Breathable and comfortable
- Withstands repeated industrial launderings without losing FR protective properties
- Molten metal splash resistance for ferrous metals

FABRIC COMPOSITION & CHARACTERISTICS

- Valen-T, the base fabric, is coated and cured with Quantum, a proprietary polymer
- Base fabric is composed of 52% cotton, 22% modified acrylic type-F, 19% viscose, 6% para-aramid, 1% anti-static
- Fabric Weight: 11 oz. / sq. yd.
- CPA Fabric Designation: VQN



Marlan® Plus, a blend of wool, viscose FR, polyamide, and TENCEL, was designed by Marina Textil to protect from molten metal splash. Marlan® Plus sheds aluminum, and protects against a variety of other molten metals, namely copper, ferrous metals, zinc, nickel, and lead. Marlan® also displays fantastic thermal insulation properties.

By its nature, the wool in Marlan® Plus is protective against flame and heat. It has a high LOI (Limited Oxygen Index), high ignition temperature (570° C-600° C), and high nitrogen content (to extinguish flame). Wool fibers foam when a heat source is applied, and produce an insulation char. The high humidity absorption in the blend helps delay a combustion reaction.

The addition of TENCEL to the blend enhances Marlan® Plus's comfort. It wicks away moisture and its fibers are soft and flexible, producing a smooth feel against the skin. TENCEL is also inherently odor resistant, without the need for treatments and additives.

Marlan's protective properties are inherent and its protection level will not decrease with the fabric's use, or after repeated laundering.

KEY FEATURES

- Sheds a variety of molten metals
- High protection with less weight and bulk
- Comfortable, smooth to the touch
- Wicks moisture, durable
- Excellent thermal insulation
- Protection level maintained through regular use and repeated laundering
- Available in a variety of colors

FABRIC COMPOSITION & CHARACTERISTICS

- Blend of wool, viscose FR, polyamide, and TENCEL
- Fabric Weights: 9 oz. / sq. yd. and 10 oz. / sq. yd.
- CPA Fabric Designations: MP9 - 9 oz. and MP10 - 10 oz.



600 style jacket
and
606 pant in
Marlan® Plus

FABRIC DATA & CERTIFICATIONS

EN ISO 11612

ALUMINUM SPLASH

10 OZ. / SQ. YD.

D1

D2

D3

IRON SPLASH

10 OZ. / SQ. YD.

E1

E2

E3

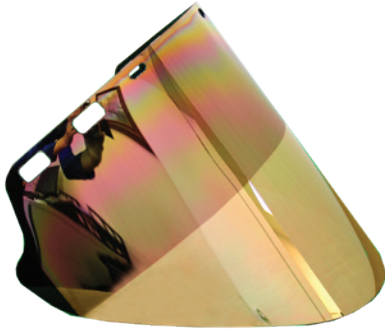

Gold Flux Face Shield

This industrial shield measures 10" x 20" x .060". Designed with a 4" gradient tint strip across the top of the shield. This feature provides the wearer with varying degrees of protection from bright light, with the clear base allowing for visibility when walking or maneuvering. The gold heat-reflective coating is protected with a hard coating to improve service life, and the inside of the shield is hard coated to minimize abrasion. Protects against radiant heat, sparks, splash from molten metals. 8 oz. polycarbonate. Clear / Green / Gold Color.

Part # WV-647-GG

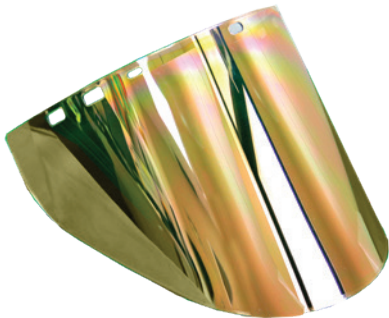

Gold Face Shield

An injection molded shield measuring 10" x 20" x .060". The gold heat-reflective coating is protected with a hard coating to improve service life. Protects against radiant heat, sparks, splash from molten metals. 8 oz. polycarbonate. Clear / Gold Color.

Part #WV-647-GOLD



ESD-690-Style Green FR Cotton Spark Deflector

Fire-resistant economy spark deflector made for use with hard hat. Four webbing straps loop over hard hat suspension and snap in place. Made from 9 oz. green FR cotton. Available in various fabrics.

Part #ESD-690-GR



690-Style Green FR Cotton Spark Deflector

Fire-resistant deluxe Velcro® design spark deflector. Four Velcro® straps attach FR green band to inside of hard hat suspension. The removable deflector attaches to the green band with Velcro®. Made from 9 oz. green FR cotton. Available in various fabrics.

Part #690-GR

UNDERGARMENTS

Flame-resistant (FR) undergarments play an essential role in protecting wearers against serious burn injuries and more common nuisance burns. In dangerous situations, having this layer of defense close to the skin may

buy the wearer critical time to escape without severe or life-threatening burns and injuries.



CarbonX® Ultimate™

The CarbonX® Ultimate™ Baselayer provides the highest level of protection for professionals working in extreme conditions where safety matters most. It is made from a double jersey interlock knit comprised of a proprietary blend of high-performance fibers. At only 8 oz. / sq. yd. it is very light, comfortable, and wearable.

Part # CX-54: Long Sleeve Shirt
Part # CX-55: Long Johns

CarbonX® Active

The CarbonX® Active Baselayer is the ideal solution for wearers who want to keep safe, yet comfortable, in warmer conditions. It is made from a light summer weight, 6 oz. / sq. yd. double jersey interlock knit. This fabric blend is made up of a proprietary blend of high-performance fibers, including a hydrophilic fiber designed to absorb and wick away moisture.

Part # CXA-54: Long Sleeve Shirt
Part # CXA-55: Long Johns

BALACLAVAS & HOODS

CarbonX® Classic Hood

The CarbonX® Classic hood is made from knit CarbonX®. CarbonX® is a blend of high-performance fibers, that will not burn, melt, or ignite, even when subjected to direct flame. Meets NFPA 70E. Long style.

Part #KC-51: Two-ply: Rated at 23 cal / cm² ATPV

Part #KC3-51: Three-ply: Rated at 53 cal / cm² ATPV



CarbonX® Ultimate Flared Hood

The CarbonX® Ultimate flared hood provides maximum coverage. CarbonX® provides users with protection from flame and electric arc. The high-performance fibers in CarbonX® will not burn, melt, or ignite, even when subjected to direct flame. Our hood features flat stitching and seamless chin area for better fit and comfort. Two-ply. Long style. Rated at 23 cal / cm² ATPV.

Part #KCF-51



0647 HOOD

Complete head and shoulder coverage. Ratcheting head gear is designed to be worn directly on head. Hard cap options available. Large 7" x 11" window opening with replaceable gold film and Lexan® window.



220 HOOD

7" x 11" lift front window and shoulder slits. Only available in AKV (aluminized para-aramid blend).



WV-647 HOOD

Provides maximum peripheral vision. Hood is designed to be worn over a hard cap. Excellent for radiant heat. Not recommended for areas exposed to heavy molten splash. 40% greater peripheral view than hoods with standard 7" x 11" window openings.

GLOVES

Our gloves and mittens come in standard lengths of 11", 14", 18", and 23". We use many different fabrics, and offer a variety of options and features. Customization is available upon request.

We also carry open and closed top cover mitts which can be slipped over gloves or mittens to protect, economize, and lengthen their life.

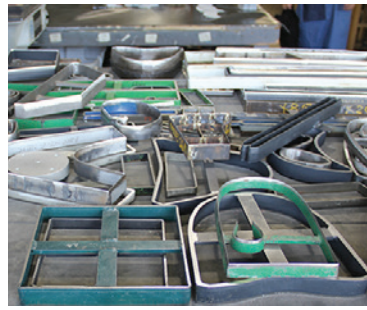

PARA-ARAMID GLOVE

22 oz. para-aramid and fiberglass blend. 400-600°F working temperature. Able to resist higher temperatures intermittently. Good abrasion resistance. Fully wool lined. 14" length. Part #234-KV



PARA-ARAMID BLEND COMBO GLOVE

19 oz. aluminized para-aramid blend on back, for near 2000°F radiant heat protection. 22 oz. para-aramid blend palm for working temperature of 400°F to 600°F, and good cut and abrasion resistance. Part #234-AKV-KV



PBI® BLEND GLOVE

22 oz. Polybenzamidazole blend offers higher working temperatures-near fiberglass levels-with superior abrasion resistance. Fully wool lined. 14" length. Also available in 45 oz. PBI®. Part #234-PBI-22



PARA-ARAMID BLEND OPEN TOP COVER MITTS

22 oz. para-aramid blend. Working temperature of 400°F to 600°F, and good abrasion resistance. 8" length, jumbo size, reversible. Available in any fabric. Part #105-OTJ-KV



ZETEX PLUS® GLOVE

35 oz. Zetex Plus® treated fiberglass. Double-layered palm, recommended when working with high temperatures. Short duration up to 1800°F. Part #FD-234-ZP



ZETEX PLUS® & LEATHER GLOVE

Leather reinforced palm combined with 35 oz. Zetex Plus® treated fiberglass. Short duration up to 1800°F. Part #FA-234-ZP



ZETEX PLUS® MITTENS

35 oz. Zetex Plus® treated fiberglass. Short duration up to 1800°F. 14" length with double layer palm. Part #184-ZP-14



ZETEX PLUS® CLOSED TOP COVER MITTS

35 oz. Zetex Plus® treated fiberglass. Short duration up to 1800°F. 9" length, jumbo size, reversible. Available in any fabric. Part #105-CTJ-KV

GLOVE OPTIONS

Glove Length	Single Layer	Leather Reinforced Palm	Para-Aramid Blend Reinforced Palm	Zetex® Plus Reinforced Palm
11"	231-fabric	FA-231-fabric	FB-231-fabric	FD-231-fabric
14"	234-fabric	FA-234-fabric	FB-234-fabric	FD-234-fabric
18"	238-fabric	FA-238-fabric	FB-234-fabric	FD-238-fabric
23"	243-fabric	FA-243-fabric	FB-234-fabric	FD-243-fabric

MITTEN OPTIONS

Mitten Length	Single Layer	Quilted Palm	Double Layer Palm
11"	171-fabric	Q171-fabric	184-11-fabric
14"	174-fabric	Q174-fabric	184-14-fabric
18"	178-fabric	Q178-fabric	184-18-fabric
23"	183-fabric	Q183-fabric	184-23-fabric



ALUMINIZED RAYON & LEATHER GLOVE

Gunn cut, aluminized rayon back, 18" in length, jumbo size. Pull strap on cuff for adjustable fit.
Part #901-AR-18-JUMBO



LEATHER & PARA-ARAMID FELT GLOVE

Welder's style glove. Welted, lined with para-aramid blend felt. Provides excellent cut and abrasion resistance, in addition to high heat resistance. Sewn with para-aramid blend thread.
Part #901-CL-KF



ALUMINIZED CARBON PARA-ARAMID BLEND & LEATHER GLOVE

Gunn cut, aluminized carbon para-aramid blend back. Brown thermal leather withstands premature hardening up to 500°F. Good abrasion resistance. Wool lined. 18" in length.
Part #901-ACK-THLNS-16



LIBERTY HEAT GLOVES

With its unique fourchette construction and four-ply layering, this glove provides outstanding, yet economical, heat protection for extended time. They remain durable, pliable, and comfortable in temperatures up to 500°F.
Part #213-DW



HOT NOT GLOVES CK

Carbon para-aramid blend outer shell and cotton / wool inner shell. Resistant to high heat, cut, and abrasion. Enables constant handling of many materials up to 450°F, intermittently up to 700°F, and incidental contact with flame.
Part #HNG-CK



SQUARE HAND PAD

One layer of wool quilted between two layers of fabric, i.e., Fabric-Wool-Fabric. Specify fabric: Kevlar®, Zetex Plus®, Zetex®, Blackflex, leather, or other. Available in different fabrics and sizes.
Part #709-SIZE-FABRIC



CHICAGO PROTECTIVE APPAREL

8051 Central Park Avenue
Skokie, Illinois 60076

Tel. 847.674.7900

sales@chicagoprotective.com
www.chicagoprotective.com

